

4

# I - V<sub>t</sub> and C - V characteristics of n - GaN - metal contact devices

S.S. AL-AMEER\* and F. M. AL-MARZOUKI

Department of Physics, Faculty of Science, P.O Box 9028,  
King Abdulaziz University, Jeddah - 21413 (Kingdom of Saudi Arabia)

(Received: February 03, 2007; Accepted: March 06, 2007)

## ABSTRACT

Gallium nitride (GaN) is a next-generation semiconductor material with excellent potential for a range of technological application, extending beyond the possibilities of established materials such as Si and GaAs. GaN is a wide band gap semiconductor making it well suited to blue/ violet light-emitting diodes, lasers and optical detectors, valuable for a range of application including wide bandwidth optical communications, high-density data storage, and energy-efficient generation of natural white light. Its wide band gap and high chemical stability also offer the prospect of high temperature electronic devices, of particular interest for down-hole instrumentation in the oil and gas industry and elsewhere. High saturated drift velocity and high thermal conductivity are valuable for high power switches for traction motor control, and devices for microwave generation. Tremendous amount of research activity is taking place world wide in fabricating and characterizing devices made from III-Nitrides and their alloys. We have carried out the current-voltage measurements and obtained clear rectifying junction for the case of GaN-Au, while the system of Al-GaN-Al showed omic characteristics. Doping concentration and barrier height have been determined from the capacitance-voltage measurements.

**Key words:** Metal - semiconductor, I-V characteristic, temperature.

## INTRODUCTION

### 1.1 Metal Semiconductor Contacts

Recently, modern semiconductor and vacuum technology has been employed to fabricate reproducible metal-semiconductor contacts so that it is now possible to obtain both rectifying and nonrectifying metal-semiconductor junctions. The nonrectifying junction has a low ohmic drop regardless of the polarity of the externally applied voltage and is called the ohmic contact. All semiconductor devices need ohmic contacts to make connections to other devices or circuit elements. The rectifying junction is commonly known as the Schottky barrier diode. In what follows we briefly review the properties of the Schottky barrier junction and the current-voltage characteristics.<sup>1, 2</sup>

Consider the Schottky effect for a metal on n-type semiconductor for a forward biased junction (the applied voltage V from the metal to

the semiconductor is greater than zero). The built-in potential  $V_{bi}$  ( $V_b$  at  $V=0$ ) for the n-type semiconductor is given by

$$V_{bi} = \phi_{Bo} - V_n \quad \dots(1)$$

where  $\phi_{Bo}$  is the barrier height of a real metal-semiconductor contact and  $V_n$  is the potential difference between the Fermi level and the bottom of the conduction band can be deduced from the doping concentration [1]

$$V_n = \frac{kT}{q} \ln \frac{N_C}{N_D} \quad \dots(2)$$

Similar results can be given for p-type semiconductors. In the following discussion, we concentrate on n-type semiconductors. The results are equally applicable to the p-type with appropriate changes in symbols.

Under the abrupt and depletion approximations the results for the metal-semiconductor barrier is similar to those of the one sided abrupt p-n junction and we obtain for the depletion region width  $W$ ,

$$W = \sqrt{\frac{2\epsilon_s}{qN_D} \left( V_{bi} - V - \frac{kT}{q} \right)} \quad \dots(3)$$

The junction capacitance  $C$  can be obtained from the charge  $Q$  stored in the space charge region,

$$Q = qWAN_D \quad \dots(4)$$

$$C = \frac{\partial Q}{\partial V} \quad \dots(5)$$

where  $A$  is the junction area. Combining (3), (4) and (5) we get

$$C = \frac{\epsilon_s A}{W} \quad \dots(6)$$

Taking into account the voltage dependence of  $W$ , (6) can be arranged as

$$\frac{1}{C^2} = \frac{2}{q\epsilon_s N_D A^2} \left( V_{bi} - V - \frac{kT}{q} \right) \quad \dots(7)$$

or

$$-\frac{d(1/C^2)}{dV} = \frac{2}{q\epsilon_s N_D A^2} \quad \dots(8)$$

If  $N_D$  is constant throughout the depletion region, one should obtain a straight line by plotting  $1/C^2$  versus  $V$ . If  $V$  is not a constant, the differential capacitance method can be used to determine the doping profile from (8) <sup>1</sup>.

The current-voltage characteristics of a Schottky barrier rectifier is usually expressed by

$$I = I_s \left[ \exp\left(\frac{qV}{nkT} - 1\right) \right] \quad \dots(9)$$

with

$$I_s = AR^* T^2 \exp\left(-\frac{q\phi_B}{kT}\right) \quad \dots(10)$$

where  $R^*$  is the Richardson constant. The ideality factor  $n$  in (9) is equal to unity when thermionic emission over the barrier dominates other transport mechanisms. Due to image force induced lowering of the potential energy for charge carrier emission when an electric field is applied the barrier height is lowered by <sup>1</sup>

$$\Delta\phi = \sqrt{\frac{qE_{\max}}{4\pi\epsilon_s}} \quad \dots(11)$$

According to (10) and (11)  $\ln I_s$  varies linearly with  $E_{\max}^{1/2}$  or with  $V^{1/2}$ ,  $V$  being the reverse voltage, as a result of Schottky barrier lowering.

## 1.2 Physical Properties Of GaN

Recently Gallium nitride and related compounds have started study intensively. Therefore, the present study of them is far less than of silicon and gallium arsenide, for instance. Gallium nitride is the most promising for high power, high temperature, and high frequency device applications. For all these applications a sound and reliable data base and understanding of the physical properties are necessary, and much work still remains to be done in this area.

## 1.3 Electronic Band Structure

Gallium nitride is a chemically stable compound semiconductor with a wide direct band gap of 3.2 eV and 3.39 eV for the  $\beta$  (cubic) and  $\alpha$  hexagonal structures, respectively <sup>3,4</sup>. Due to wide direct band gap, the most important property of GaN is efficient light emission and lasers.

The band structure of GaN is quite close to that of direct band gap zincblende semiconductors such as GaAs, but there are significant differences concerning the valence band. One key difference is that the valence band degeneracy is lifted in GaN by wurtzite crystal field<sup>4,5</sup>. Therefore, the valence bands near  $\Gamma$  show a very characteristic splitting into three bands due to crystal field splitting and spin-orbit interaction<sup>4,5</sup>. The holes in these three bands are conventionally called A-, B- and C-type holes<sup>3</sup>. Crystal field splitting is absent in the zincblende structure and therefore,

the heavy and light hole bands degenerate at  $k=0$  for zincblende GaN.

## EXPERIMENTAL

### Wafers description

ATMI<sup>6</sup> supplies n-type and undoped GaN and  $(\text{Al}_{0.25}\text{Ga}_{0.75}\text{N})$  epitaxial layers on sapphire. The thickness of these layers varies from  $0.1\ \mu\text{m}$  to  $2\ \mu\text{m}$  ( $0.1\ \mu\text{m}$ ,  $0.5\ \mu\text{m}$ ,  $1\ \mu\text{m}$  and  $2\ \mu\text{m}$ ). The n-type layers are heavily doped with Si to  $2.2 \times 10^{19}\ \text{cm}^{-3}$ . The doping concentration of the undoped layers is less than  $10^{16}\ \text{cm}^{-3}$ .

A buffer layer of undoped AlN (less than  $10^{16}\ \text{cm}^{-3}$ ) of thickness  $0.04\ \mu\text{m}$  is used. Moreover, for doped layers a thin undoped layer of thickness  $0.02\ \mu\text{m}$  is first grown on the buffer before the doped layer to prevent pitting that doped layer. It should be noted that even with the undoped starting layer, the heavily doped epilayer may be pitted. It should also be noted that doped layers of thickness  $1\ \mu\text{m}$  may have some cracking, while those of thickness  $2\ \mu\text{m}$  will crack.

With the above description of epilayers supplied by ATMI, we received n-type doped and undoped layers of thickness  $0.5\ \mu\text{m}$ . We received these wafers in sealed plastic bag with evacuated air.

### Sample Cleaning Procedures

Gallium nitride wafers have been used in this work as a substrate. These wafers were cleaned chemically according to the following procedures:

- 1) Remove dust of substrate (GaN) with dry compressed nitrogen gas.
- 2) Immerse in 200 ml of HCL and 50 ml of  $\text{H}_2\text{O}_2$ , which all in glass baker to be placed on hot plate for about 10 minutes.
- 3) Rinse in deionised water.
- 4) Immerse in circulating DI water both bath for 30 minutes.
- 5) Immerse in dilute ( $\text{HCL} : \text{HNO}_3 = 3:1$ ) until the surface becomes hydrophilic.
- 6) Rinsing in deionised water followed by deionised water cascade for 15 minutes.
- 7) Blow drying the substrate using dry compressed nitrogen gas.

### Contact fabrication

Thermal evaporation is carried out in vacuum by heating the source material (Au or Al) to a temperature sufficiently high to allow a

reasonably high rate of evaporation. The purity of the evaporation materials were 99.99%. Mechanical mask was used to form contact solid pattern film on the gallium nitride wafer. This mask made of aluminum sheet, which containing many circular hole of diameters from  $1\ \text{mm}$ ,  $2\ \text{mm}$  and  $3\ \text{mm}$ . A system of vacuum we used is an Edward 306 coating unit. This system containing of a rotary pump, a diffusion pump and a vacuum chamber. The pressure in the vacuum system must be sufficiently low so that the vapor atoms or molecules travel in a straight line from the source to the substrate without colliding with the ambient gas molecules. This requires pressure lower than  $10^{-5}$  torr, but even lower pressure is desirable to minimize the adsorption of the residual gases on the substrate. Metal evaporation was carried out at a pressure of  $10^{-5}$  torr. Prior to evaporation, the metal source (Molybdenum boat) was cleaned using degassing process. A built-in shutter is used to control the deposition of metal onto the GaN wafer. A distance  $20\ \text{cm}$  between the holder sample and the molybdenum boat was fixed.

### Equipment to test the prepared samples

RLC meter (Fluke PM6306) is installed and connected to the computer via the SW63W software Component system. A programmable Neytech Qex furnace has installed. The furnace is equipped with Neytech programming software that allows PC to control the furnace temperature and pressure to allow measurements under vacuum. Figure 1. Two samples have been prepared, one of these sample is Au-GaN and the other Al-GaN. For measuring small currents, a good electrical contact in every part in the circuit is an important issue. The current noise from the outside environment must also be minimized. The probe is an important element in the measuring circuit. It must give good electrical connection to the sample. The force exerted by the pin of the probe must not damage the surface of the sample (evaporated material). It must support high temperature when it is placed inside the furnace. We first designed our probe, which contains base and two pins. The whole device made from copper and teflon is shown in figure 2, where the connection force is provided by flexible spring. After using the probe, we found the electrical connection to the sample was not good, because that the pin caused a damage to the surface of the sample (evaporated material). This problem has been solved by replacing the pins with two carbon pins, which did not make damage to the surface of the sample and give a good electrical connection.

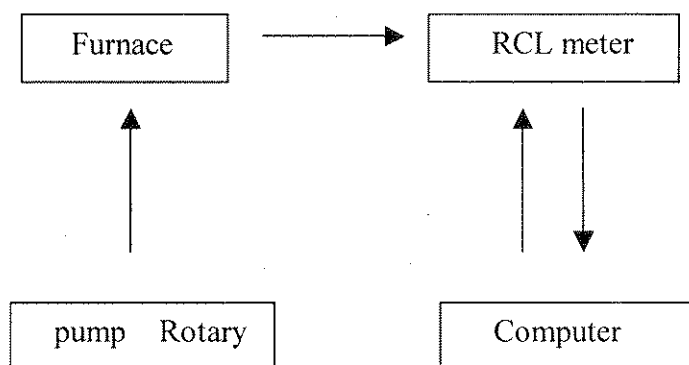

Fig. - 1: Lay-out of measuring equipment

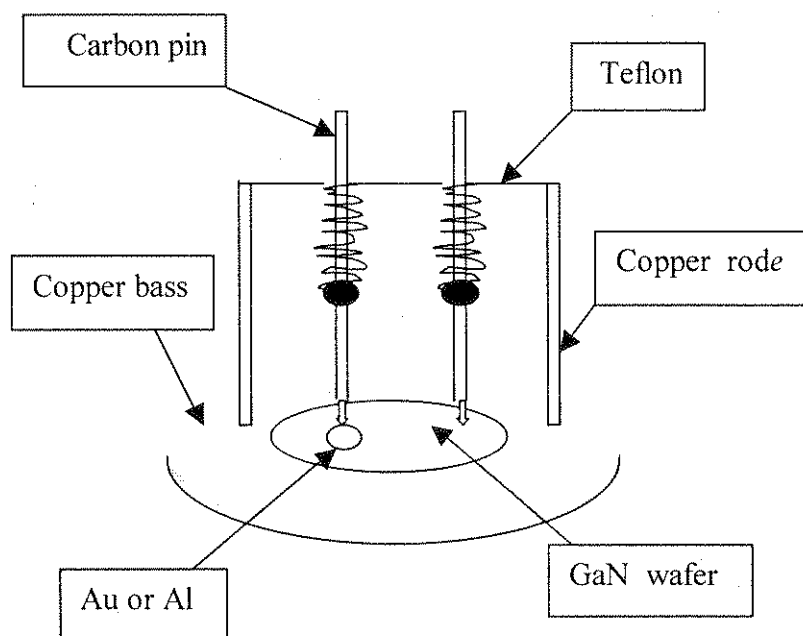

Fig - 2: Two probe measurements

## RESULTS AND DISCUSSION

### Current-Voltage characteristics

Ohmic contacts to GaN have been made by evaporating Al to GaN. The current-voltage characteristics of the system Al-GaN-Al is shown in Figure 3. The ohmic nature of the contact is clear from the linearity of the obtained curves. I-V measurements were performed at different temperatures ranging from 300 to 420K for both forward and reverse bias. The I-V measurements

as a function of temperature give insight on the effect of the oxide layer, the Schottky barrier lowering effect, the non-ideal back contact effect, and surface states for both the forward and reverse characteristics. Figure 4 reports typical I-V characteristics at different temperatures. Rectification is clear for the Au contact to GaN. With increasing temperature the turn on voltage tends to decrease slightly. It should be noted that the non ideal ohmic contact results in a greater turn on voltage. Figure 5 shows the forward I-V

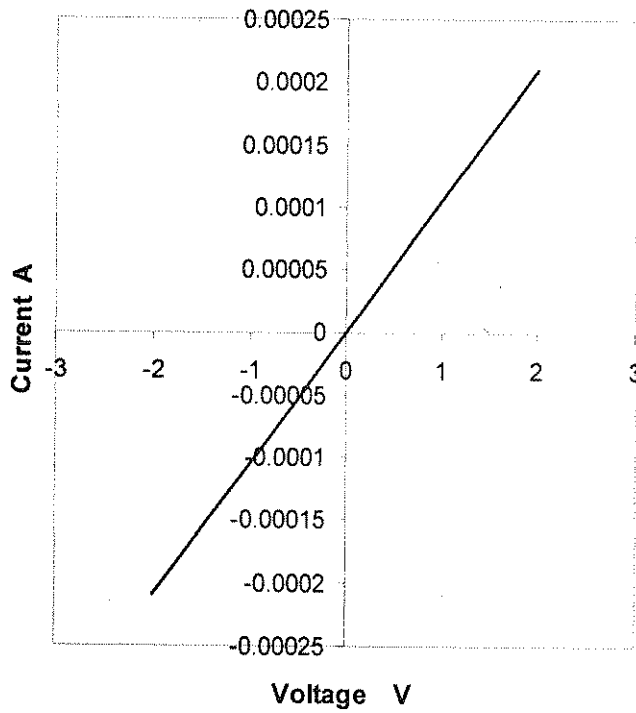

Fig. - 3: Current-Voltage characteristics of Al-GaN-Al structure

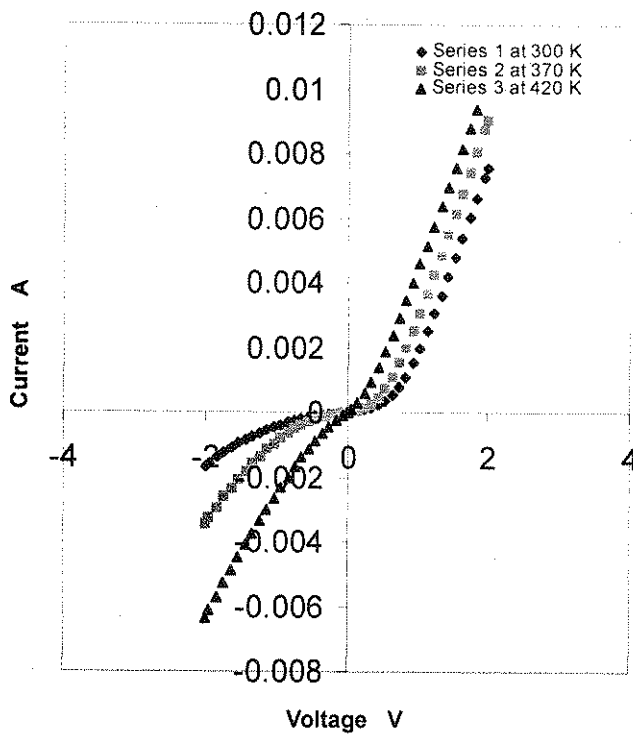

Fig. - 4: Typical I-V characteristics of the n-GaN-Au contact

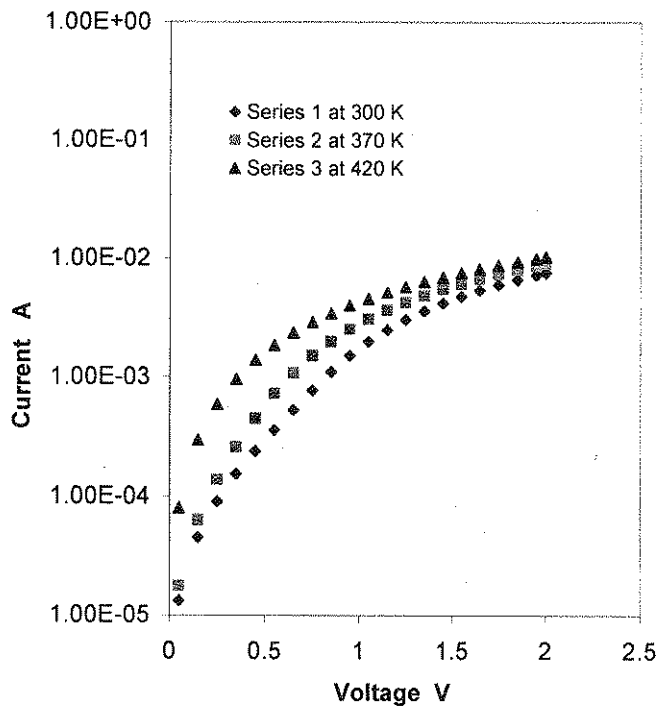

Fig. - 5: Semi-logarithmic plot of the I-V characteristi of the n-GaN-Au contact

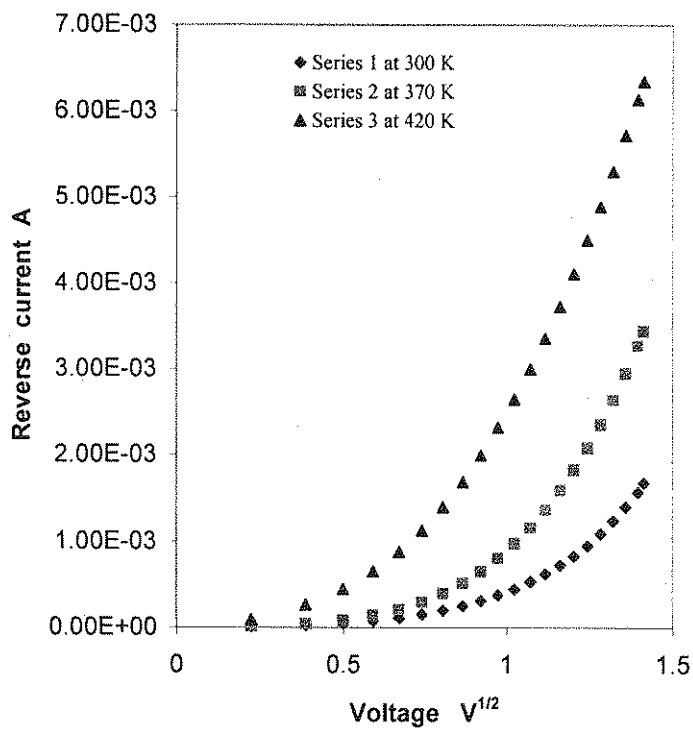

Fig. - 6: Current versus the square root of the reverse voltage for the n-GaN-Au contact

characteristics on a semi-logarithmic plot. The plots do not form straight lines over the whole range of voltage. The value of the ideality factor  $n$  is calculated from the slopes of the graphs using equation (9). For lower bias voltages the ideality factor was found to have a value of  $n$  greater than 2. For large bias voltage the ideality factor had very large values. Such a behavior is commonly associated with series resistance. Figure 6 also shows the I-V characteristics in the reverse bias. The current is observed to increase with increasing temperature. This can be explained by carrier generation in the depletion region; most of the electron-hole pairs generated are separated by the high field in the depletion region and are then collected by the electrodes giving higher saturation currents. Another possibility is the excitation of electrons from the metal into the semiconductor which increases with temperature as given by equation (10).

The reverse current is plotted against the square root of the voltage on a semi-logarithmic plot in Figure 6. The plots become linear after about 1 V, but only at high temperature. For voltages in excess of 1 V the field becomes high enough for

the Schottky lowering effect to assert itself. At high fields the Schottky barrier is considerably lowered according to equation (11). Another interpretation is in terms of the generation current which is proportional to the width of the space charge region  $W$ , while  $W$  varies as  $V^{1/2}$  as given by equation (3). The later effect is more significant at high temperature due to the rapid increase in intrinsic carrier concentration with temperature.

#### Capacitance Voltage measurements

Depletion layer capacitance measurements give information about fixed impurity and defect centers in the semiconductor as well as the metal to semiconductor barrier height. All C-V measurements were performed at room temperature for reverse bias in the range 0-3 V. The capacitance  $C$  is then plotted as  $1/C^2$  versus voltage.

From the C-V measurements the doping concentration and the built-in potential  $V_{bi}$  can be obtained. Knowing the doping concentration, the difference in the energy between the bottom of the conduction band in an n-type material (or the top of the valence band in p-type material) and the

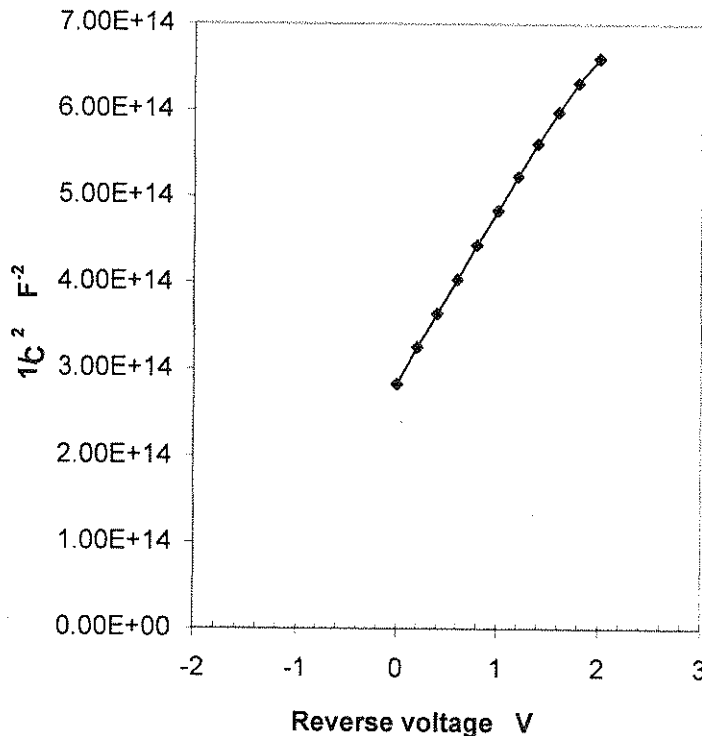

Fig. - 7: The reciprocal of the square of the capacitance versus the reverse bias for n-GaN-Au contact. Diode area = 0.071 cm<sup>2</sup>. The built-in voltage  $V_{bi}$  is found from the intercept with the voltage axis to be about 1.45 V.

Fermi level  $qV_n$  (or  $qV_p$ ) can be determined, from which the value of the barrier height can be obtained. The C-V characteristics in the reverse bias are found<sup>1,2</sup> to follow the depletion layer capacitance theory. From Figure 7, it is clear that the plot of  $1/C^2$  forms a straight line for n-type GaN thin films implying that the donor doping concentration is constant throughout the depletion region. The value of the acceptor concentration  $N_A$  can be calculated using the slope of  $1/C^2$  versus  $V$  plots. The doping density is given by equation (8) repeated here for convenience in the form

$$N_{D,A} = \frac{2}{q\epsilon_s A^2} \left[ -\frac{d(1/C^2)}{dV} \right]^{-1} \quad \dots(12)$$

where the dielectric constant  $\epsilon_s = 8.9\epsilon_0$  for GaN<sup>6</sup>. Calculations were related to the doping concentrations  $1.54 \times 10^{19} \text{ cm}^{-3}$ . The barrier height can be calculated using (1) and (2) and the intercept with the voltage axis in Figure 7. The barrier height is found to amount to 1.95 V.

## CONCLUSIONS

Our main object of this study was to study and analysing the characterization of the I-V<sub>f</sub> and C-V for the n-GaN-metal contact. This study showed very good I-V<sub>f</sub> and C-V curves, however in terms of I - V<sub>f</sub> curves varies temperature had been adopted and rectifier devices have been obtained, from these measurements ideality factor has been calculated and found to be in good agreement with theoretical study, taken in account the effect of the cleaning procedures of the sample (GaN wafer), since we could not avoid small layer of oxide that effect these measurements, but it was very minimal, also C-V curve was measured at room temperature and barrier height was calculated and good value was obtained.

Finally it has been found that these devices after several trial were not effected by the surrounding environment.

## REFERENCES

1. S. M. Sze, *Physics of Semiconductor Devices*. Wiley, New York, p. 245 (1981).
2. E. H. Rhoderick. *Metal Semiconductor Contacts*. The institute of physics, London, p. 3 (1974).
3. S. Nakamura, S. Pearton and G. Fasol. *The Blue Laser Diode*, Springer, Berlin, p. 7 (2000).
4. W. R. Lambrecht and B. Segall *Properties of Group III Nitrides*. EMIS Datareviews Series, edited by J. H. Edgar, INSPEC, London, p. 30 (1994).
5. S. Nakamura, S. Pearton and G. Fasol. *Physics of Gallium Nitride and Related compounds*. Springer, Berlin, p. 29 (2000).
6. ATM: (GaN wafer supplier), Commerce Drive, Danbury, CT 06810, USA.